



SOLAR PANELS

Affordable Solar Power for Generations





INTRODUCTION

Magnizon is a ISO9001:2015 & ISO14001:2015 certified global manufacturing firm with strong focus on Product engineering, research and development, production, sales and services in the field of green energy power product lines. Production range includes of PV solar module both poly and mono with industry best standards and quality. Our PV modules are produced by 100% automatic(advanced robotic) production lines and approved by TUV, IEC, CE, CEC, CQC and FIDE. Team with top R&D talent with 20+ years of multinational corporate experience and assembled senior marketing, product and sales teams who live by the MNC spirit of “Professionalism, Integrity, Innovation and Win-Win”. From our base in Dubai-UAE we serve markets across Middle East, Africa and central Asia. Our products are supplied, deployed and working successfully with 100% customer satisfaction across 32 countries.

CHOOSING MAGNIZON,
YOU GET BETTER
ENGINEERED
PRODUCTS, YOU
ALSO GET OUR
PROVEN RELIABILITY,
OUTSTANDING
CUSTOMER SERVICE
AND THE ASSURANCE OF
OUR 25-YEARS LIMITED
WARRANTY.

KEY FEATURES:

- Maximum system voltage: 1000v(Option of 1500V with prior request)
- Operating temperature range: -40DegC to 85DegC
- Surface maximum load capacity: 200kgs/Sq.m
- Built in IP67 Rated junction box with 3 bypass diodes
- Built in +ve & -ve cables lengths of 900mm
- Positive power tolerance(0-3%) to ensure the high reliability of power output
- Solar cells made in : Germany/Japan/Taiwan (options to choose by customer)
- Easy installation and maintenance with compatibility to industry standard inverters and mounting system
- Anti-reflective, hydrophobic layer of module surface(proprietary 800°C online coating technology) improves light absorption and reduces surface dust
- Excellent performance under low light environments(mornings, evenings and cloudy days) create better kWh/kW ratio and produce average 5-6% more yield
- Special PV Module Insurances by world leading insurance company guarantees the benefit of PV investors and users
- Junction box and bypass diodes guarantee the module free of overheating and “hot spot effect”
- IEC 61215, IEC 61730-1/2, IEC 61701, CE, EMC, ISO 9001:2015, ISO 14001:2015 & ROHS compliance

PRODUCT CHARACTERISTICS:



High efficiency crystalline PV modules is applicable to residential and public roof tops and ground mounting PV power stations



Main bus bars PV cells (5BB), more uniform current collecting ability, decrease current self-consumption, more beautiful product appearance



Antireflective glass not only increases light absorption, but also reduces the power loss by its self-cleaning function under rainy environment



Outstanding week light power generating performance, well suitable for cloudy and rainy environments



Excellence mechanical performance with 2400Pa wind load and 5400Pa snow load with 2xIEC standard test performance design



Certified anti salt-mist, anti-ammonia corrosion performance by TUV



Optimized current classification to improve the system power output



Excellent PID free performance



Production process using World class auxiliary materials

EVA

- Excellent anti-PID and UV- gaining properties
- Excellent durability, such as weather resistance, high-temperature, high-humidity and UV light resistance.
- Excellent long term adhesion to glass, metal and polymer back sheet.
- Excellent light transmittance and transparency.
- Good maneuverability during lamination process

SOLAR CELL

- Magnizon has established a strict solar cell procurement system in order to ensure the quality and efficiencies of solar cells.
- World class solar cell sources from Germany/ Japan/Taiwan/China gives our customers a flexibility to select products based on the budgets
- 5BB, Class A+ cells with highest efficiency in the industry
- Excellent resistance PID attenuation performance
- Anti PID-Solar cells

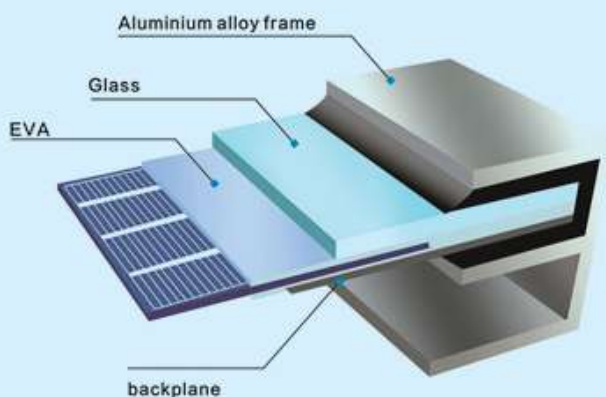

BACKPLANE

- Tetra-fluorine back at low water vapor transmittance to ensure the reliability of components and the stability in harsh environment
- High resistance to heat and humidity
- Excellent UV Blocking
- Excellent partial discharge
- High Inner Layer Reflectivity
- High Water Barrier
- Structure: Multi-layer, FFC or PVDF/Adhesive/PET/FFC

GLASS

- Reliable quality and high transparency
- Low Iron Tempered Glass
- Excellent scratch resistance
- Surface of the glass using closed-cell structure of the nano-coating to improve the reliability and antifouling performance
- Anti-acid: Transmittance Loss less than 1%
- Salt Spray: Transmittance Loss less than 1%
- Damp Heat test (double 85) : Module Max Power Loss less than 5%
- Exposure to UV Light Module Max Power Loss less than 3%



JUNCTION BOX

- Procurement from First class diode suppliers to reduces the probability of occurrence of hot spots
- Using potting junction box design to ensure a good seal performance
- True IP67 junction box made with fire retardant polymers
- TUV certified, UV rated pure copper cables and connectors

ALUMINIUM ALLOY FRAME

- High resistance to salt and ammonia corrosion performance.
- Excellent surface treatment technology, higher line density components ensures excellent corrosion resistance and mechanical strength





Product Quality Process & Warranty



QUALITY TEST & PROCESS

- Before shipping out our products, we test every single solar modules using state-of-the art testing facilities and internationally proven test methods and procedures.
- QA tests using cutting-edge equipment such as solar irradiance simulator, mechanical load tester, and electroluminescence (EL) tester.
- Infrared cameras are constantly used to supervise the testing labs' temperature and humidity.



- When packaging, all our solar modules and cells are classified and sorted according to their current characteristics and all the packages are special designed that enable our products to be free of dampness, rust, moisture, erosion and shock.
- Our products are also independently tested by global renowned testing facilities including TUV Rheinland & TUV Nord etc.



ENVIRONMENTAL ADAPTABILITY TEST

- Ammonia resistance test, resistance to salt spray test, So2 resistance test, resistance to dust test
- Adaptation to environment test: Dry and hot weather testing, hot and humid climate test, cold weather testing





LONG TERM RELIABILITY TEST

- Mechanical load test 5400PA to 10000PA (2x IEC standard requirement), HAST IEC test temperature 85deg C, RH 85% to temperature 121deg C and three times the air pressure RH100%
- Limit testing at 3times IEC standard
- 100% automation lines and independent production to ensure the highest quality and reliability

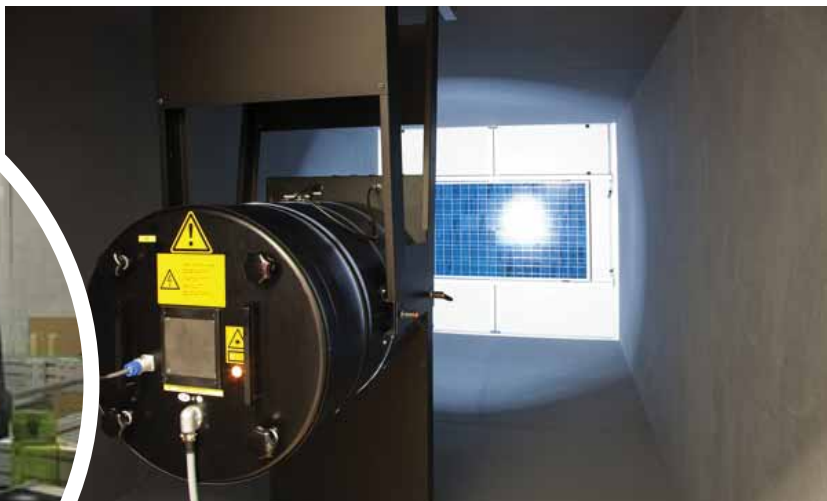
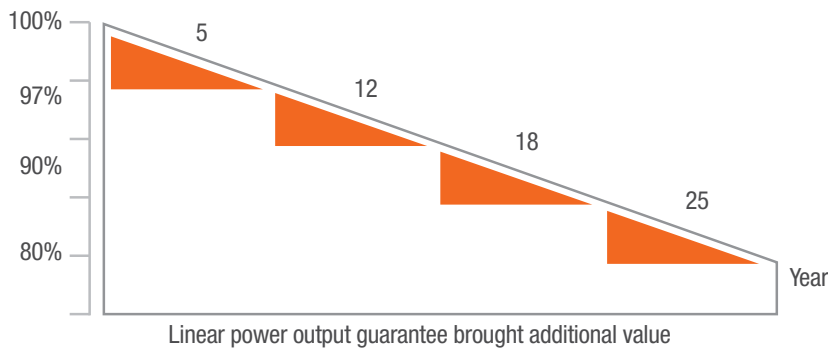

Quality Warranties



Power Warranties

15 Years Material & Workmanship Guarantee

- 95% power output guarantee for 5 years.
- 90% power output guarantee for 10 years.
- 80% power output guarantee for 25 years

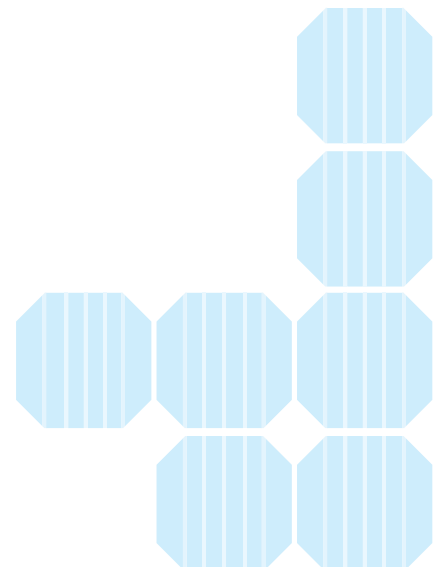

MSM150S-156 ^{5BB}

150W

Monocrystalline PV Module

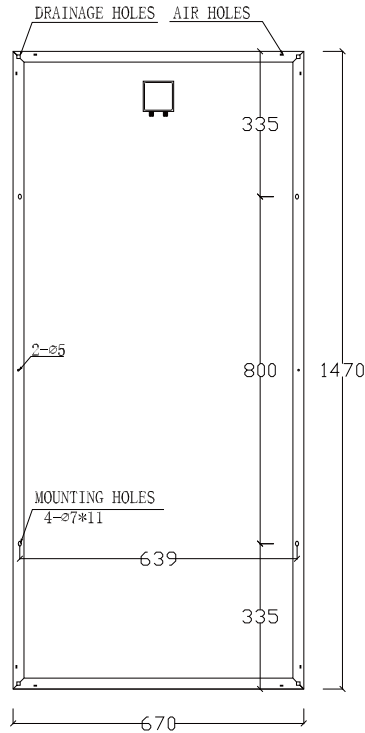
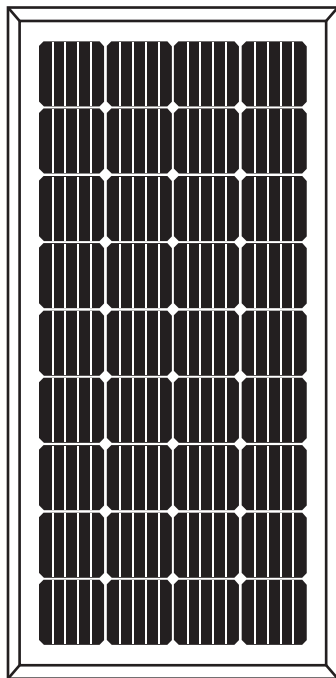

PERFORMANCE PARAMETERS

Maximum System Voltage	700V
Operating Temperature	-45~+8°C
Maximum Series Fuse	10A
Maximum Static Load, Front Side (e.x. Snow, Wind)	5400PA
Maximum Static Load, Back Side(e.x. Wind)	2400PA
Application Grade	Class A

RAW MATERIALS AND MECHANICAL PARAMETERS

Type of Cells(mm)	Mono (156 x 104)
NO. of Cells and Connections	4 x 9=36
Dimensions(mm)(L*W*H)	1470 x 670 x 30
Weight(kg)	11.0
Glass	3.2mm Tempered Glass
Encapsulation	EVA

Backsheet	Multilayer Composite
Aluminium-Frame	Silvery/Black Anodized aluminium alloy
Junction-Box	IP65/IP67
Cable	NA, but customized is acceptable
Connector	NA, but MC4 and MC4 Compatible are acceptable
Package Configuration	4pcs/ctn

ELECTRICAL PARAMETERS (STANDARD TEST CONDITION)

	MSM150S
Rated Maximum Power(Mp)	150W
Power Tolerance	0- +5W
Cell Efficiency	17.7%
Open Circuit Voltage(Voc)	22.4V
Maximum Power Voltage(Vmp)	17.5V
Short Circuit Current(Isc)	9.05A
Maximum Power Current(Imp)	8.63A
Temperature Coefficient of Isc	+0.06%
Temperature Coefficient of Voc	-0.32%
Temperature Coefficient of Pmp	-0.45%

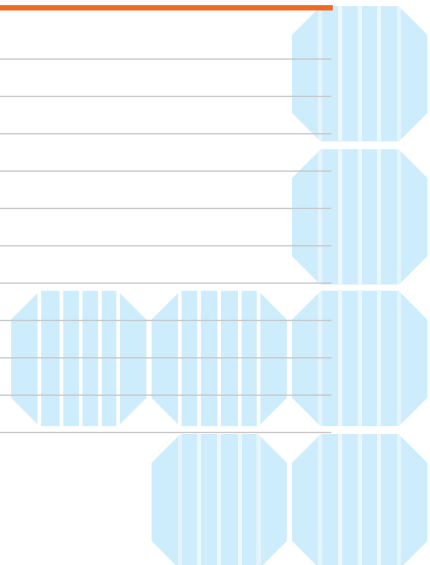

APPLICATIONS

If you are considering Magnizon solar PV technologies for your home, business, remote cabin, or farm, it is important to understand the key differences between grid-tied and on-grid systems. Installing solar panels isn't as simple as slapping cells on a rooftop. You'll need to install additional wiring, and panel placement is key to building an efficient system.

ON-GRID/OFF-GRID UTILITY



RESIDENTIAL ROOF TOP SYSTEMS



TELECOM & BTS SOLUTIONS

Photovoltaic systems are more efficient not only from an economic and financial perspective, but also from a convenient one. As the diesel generators need close monitoring and continuous refuelling which has also burdened mobile operators with additional costs of reaching out to these remote sites, it's feasible to replace them with photovoltaic systems with low operating cost and easy monitoring.



WATER PUMPING STATIONS

Agriculture solar water systems are now more affordable and efficient than ever before! With Magnizon Solar Powered Water Pumping Station you would save or eliminate fuel and maintenance costs with no inverters or batteries required and increased pump reliability with no grid interconnection required. It runs your existing 3 phase 240 volt or 480 pump up to 300 horsepower with submersible or surface pumping. Variable frequency drive soft starts the motor and automatically adjusts to available light conditions.



SOLAR LIGHTING SYSTEMS

Wide ranges of Magnizon solar panels starting from 5Wp to 330Wp are suitable for various solar lighting systems. These solar lighting systems are used for various applications such as stadium lighting, street lighting, path way lighting, garden lighting and warning lighting for extra tall buildings.



COMMERCIAL APPLICATIONS

MAGNIZON solar panels are suitable till 500MW with various industrial needs or solar power generation stations. Unique technical feature and high reliable products with highest operating efficiency ensures the ROI less than 4 years and operational life span of 25 years.



SECURITY, SURVEILLANCE AND MOBILE POWER SYSTEMS

The "WATTS ON WHEELS" concept is used in providing security in remote sites through solar powered mobile security and surveillance trailers. RV vehicles with panels mounted on top provide mobile services including mobile offices, schools, hospitals and health care services in areas without reliable power.



SOLAR POWERED TRAFFIC SIGNALING SYSTEMS AND ATMS

As these LED based signal lights consume 90% less energy, it makes system practically viable to operate traffic signals maintenance free on Solar Power. Municipalities looking for a reliable & cost effective way to power traffic lights can turn to remote solar energy systems to keep roadway infrastructure up and running during all conditions. The solar powered ATMs have been established in places where power provision may not be available. It uses MPPT technology with a two-day lithium/ deep cycle gel battery backup.



ADVERTISING BILLBOARD POWER SUPPLIES

Magnizon Solar panels can be mounted directly to any billboard structure or it can be pole-mounted a short distance away from the structure. By investing in a Solar Billboard Lighting System, you can generate your own free solar energy and cash in on a variety of benefits, including:

1. Long-term Protection from Rising Utility Rates
2. Higher Advertising Value
3. The Pride of Being Environmentally Responsible





info@magnizon.com www.magnizon.com

We conceptualize a unique way simplifying and customizing the products, at the same time ensuring best possible and optimized techno-commercial solutions to our customers.

Copyright c 2018 Magnizon. All trademarks are the sole property their respective owners. Magnizon has a policy of continuous improvement.

Specifications are subject to change without notice. Photos may change slightly from final products.

Authorised Distributor :

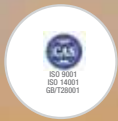
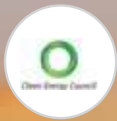
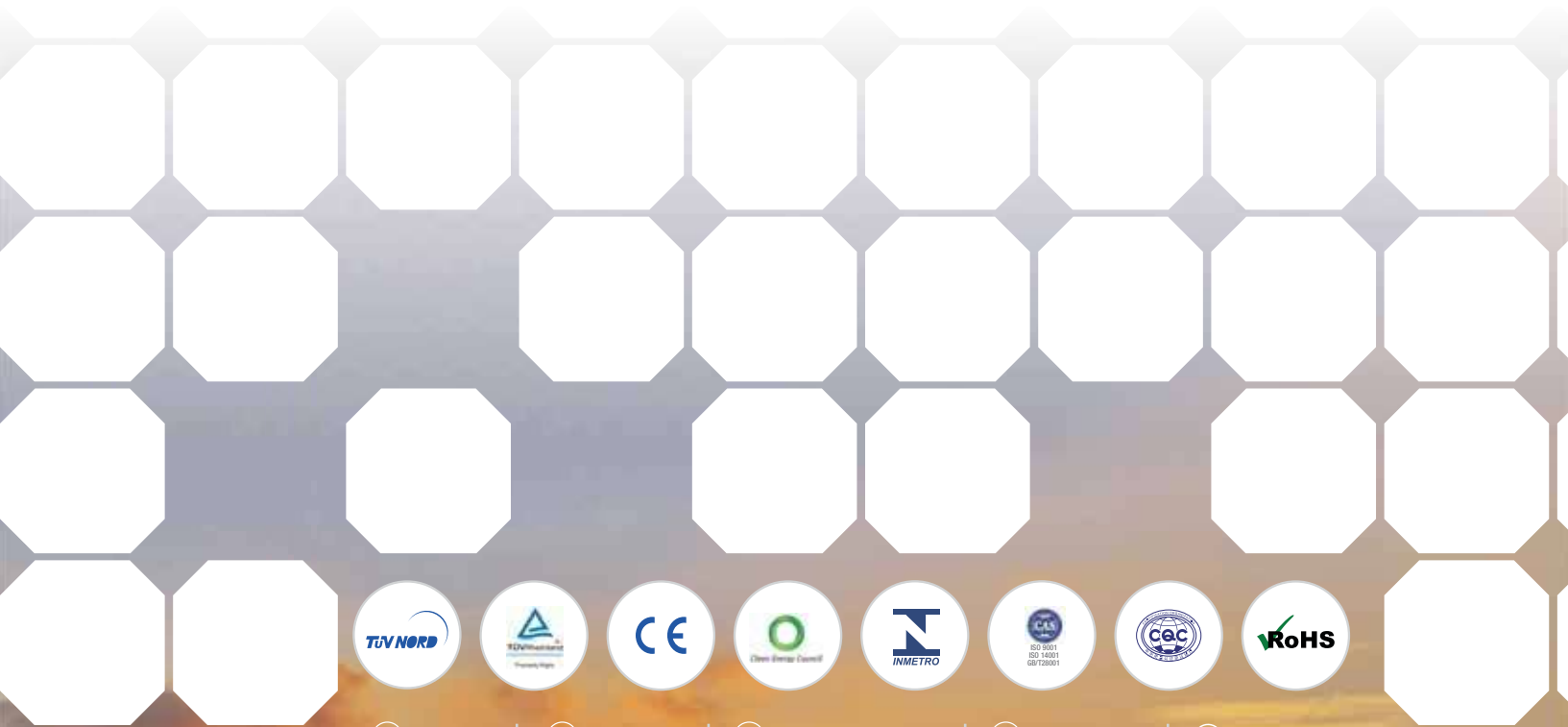

f magnizon

@ magnizon1

+971 56 63 58098

@magnizon1

in magnizon

